

Worktops

Processing guidelines



For you to create



Fundermax

Content

3	WORKTOPS
4	PROPERTIES
5	GUIDELINES FOR HANDLING MAX COMPACT PANELS
6	PROCESSING GUIDELINES FOR KITCHEN WORKTOPS
6	Construction information
8	Mechanical fastening
10	Glued fastening
12	Sink and glass top stove installation
14	THE PROCESSING OF MAX COMPACT PANELS
14	Safety measures
15	General processing guidelines
16	Cutting
17	Cutting with handheld tools
18	Milling machines – edge processing
20	Joining
21	Routers
22	CNC processing
23	Edges and grooves
23	Inner notches and cut-outs
24	Drilling
26	Basics
27	Bonded edge joints
28	Glueing
30	CLEANING RECOMMENDATIONS



Worktops

Due to their high scratch and abrasion resistance as well as high impact resistance and resistance to high temperatures, Max Compact panels are ideally suited for horizontal use as a worktop. Another advantage of these panels is the hygienically sealed, pore-free, closed surface made of melamine resin that is very easy to clean and is particularly resistant to many chemicals. Max Compact worktops are ideal for the installation of undercounter sinks and flush stovetops.

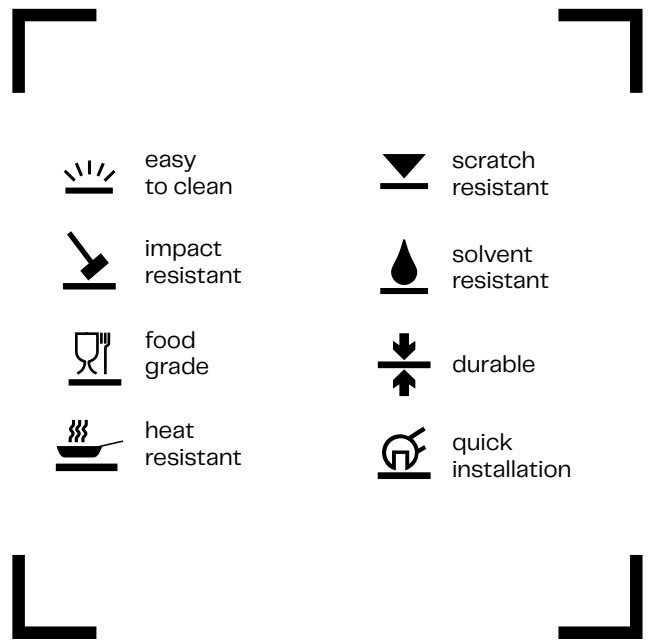

Fig. 1

MAX COMPACT PANEL WITH SAXUM SURFACE

Max Compact worktops are duromer high-pressure laminate panels (HPL) in accordance with EN 438 and are produced in laminate presses under great pressure and high temperature.

Properties



FORMAT

4100 x 1300

PANEL THICKNESS

The optimal thickness for Max Compact panels for use as worktops is 12 mm.

Different panel thicknesses, fastening distances and the expected load capacity are all directly related and must be dimensioned accordingly.

EIGENSCHAFTEN*:

- scratch resistant
- solvent resistant
- food grade
- heat resistant
- easy to clean
- hygienic
- impact resistant (en iso 178)
- decorative
- abrasion proof
- bending resistant (en iso 178)
- frost and heat resistant from -80°C to +80°C
- easy to install
- durable
- resistant to chemicals

* TECHNICAL VALUES AND FURTHER INFORMATION ON THE MATERIAL PROPERTIES IN ACCORDANCE WITH EN 438 CAN BE FOUND IN OUR BROCHURE "INTERIOR TECHNOLOGY" ON PAGE 10

Guidelines for handling Max Compact panels

TRANSPORT AND HANDLING

Handle Max Compact panels with care in order not to damage the edges and surfaces of the high-quality material. In spite of the excellent surface hardness and the installation protection film, the stack weight of Max Compact panels is a possible cause of damage. Therefore, any form of dirt or dust between the panels must definitely be avoided.

Max Compact panels must be secured against slippage during transport. When loading or unloading, the panels must be lifted. Do not push or pull them over the edge (see Fig. 2)

Transport protection films must always be removed from both sides at the same time.

Maybe there is a stronger adhesion of the foils on the surface because of the storage. Therefore there might be a higher effort to remove the foil. That does not have any effect to the quality of the product and does not result into a complaint. The transport protection film must not be exposed to heat or direct sunshine.

STORAGE AND AIR CONDITIONING

Max Compact should always be left in the original packaging. The panels should be stacked horizontally on a flat, stable and padded raised surface. If this is not possible, the panels can be temporarily stored as shown in Fig. 4. The panels must lie completely flat. After removing the panels, the original packaging should be closed again.

Cover plates must always be left on the stack (see Fig. 3). The top cover should be weighted down. The same applies, in principle, for cut-panel stacks.

Incorrect storage can lead to permanent deformation of the panels.

Max Compact panels should be stored in closed rooms under normal climatic conditions, temperature about 15°C – 25°C and relative humidity at about 40% – 60%. Climate differences on the two surfaces of a panel are to be avoided.

With pre-installed fastening elements, therefore, care is to be taken that the climatic effect is uniform on all sides. Use intermediate layers of wood or plastic (see Fig. 5).



Fig. 2



Fig. 3

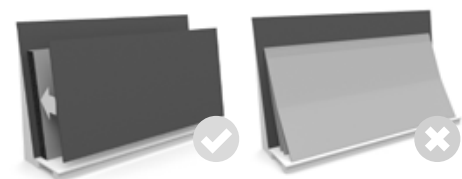

Fig. 4



Fig. 5

Processing guidelines for kitchen worktops

Construction information

Max Compact panels shrink when releasing moisture. Max Compact panels expand when absorbing moisture. When working with and using the panels in construction, these possible dimensional changes must be taken into consideration.

The dimensions of Compact panels are influenced by changes in relative humidity. It is therefore essential to ensure there is sufficient expansion space when installing the panels. As a rule of thumb, calculate 2 mm of expansion space for each meter of panel.

- Due to the material characteristics, when connecting Max Compact panels to one another (double, butt or miter), it is essential to ensure that all the parts to be connected are arranged in the same production direction. In other words, only connect horizontal with horizontal and vertical with vertical. Left over panel pieces should therefore always be marked with the production direction.
- Base cabinets and substructures should have sufficient load-bearing capacity/stiffening.
- Base cabinets and substructures should be aligned and height differences should be avoided.
- It is not recommended to make corner joints and worktop joints exclusively by gluing; these joints should always be supported by mechanical connections.
- Recesses/outlets for the sink, glass top stove, sockets, etc., must always be made with an inner radius of 5 mm. Pointed corners are not recommended.
- In general, it is important during construction and installation to ensure that the material is not subjected to accumulating moisture. The panel material must always be able to dry. It must be ensured that the rooms are adequately ventilated.
- Visible edges or edges in the handle area must be chamfered or at least broken with sandpaper to avoid injuries and material damage.
- For a perfect surface that is easy to clean, we recommend not milling the surface of Max Compact panels.
- Max Compact panels with a white core have limited suitability in heavily used areas as dirt is more visible on the white surfaces.

NOTICE:

We reserve the right to make changes that serve technical progress.

SUBSTRUCTURE

When installing the Max Compact panel, sufficient ventilation on both sides of the panel must be ensured. Different temperatures or moisture levels in front of and behind the counter-top can lead to warping of the panels. For this reason, the panels should be placed on a sufficiently stable substructure so that air circulation is guaranteed on the front and back of the panel. If the base cabinets are not strong enough, they must be reinforced with additional elements. The base cabinets and substructures should also be aligned. Any differences in height should be compensated, for example with a suitable spacer.

In order to properly “ventilate” the Max Compact panels, it is necessary to design the kitchen base cabinets with an open top so that an air exchange can take place.



EXAMPLE OF MECHANICAL FASTENING

Fig. 6

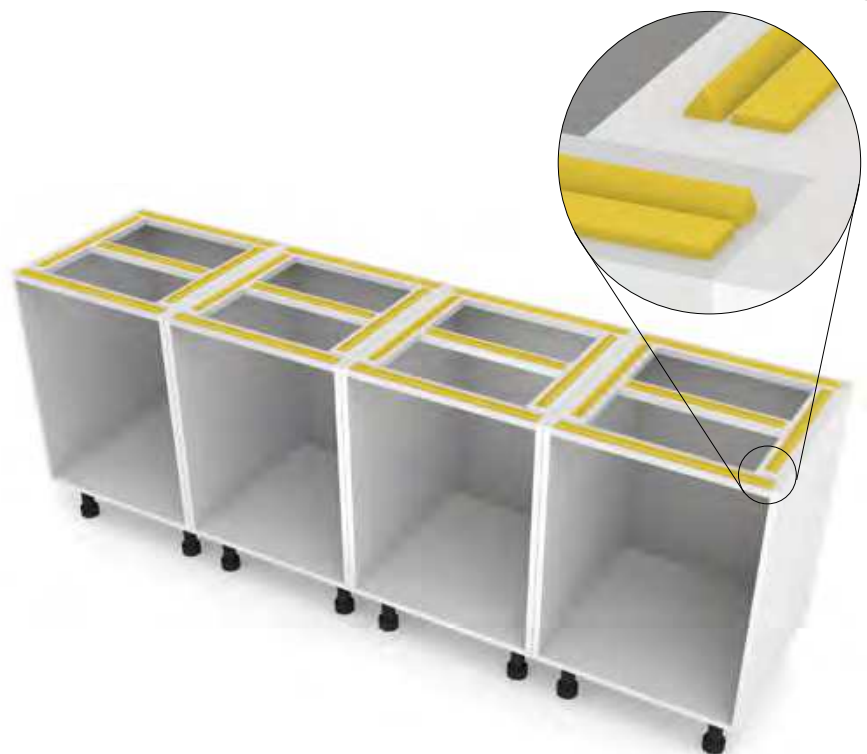

EXAMPLE OF GLUED FASTENING:

Fig. 7

Mechanical fastening

Due to the material characteristics of Max Compact panels, the fastening points must be designed as fixed and sliding points.

Fixed Point:

The fixed point serves the uniform distribution (halving) of the swelling and shrinkage movements. The drill hole for the fixed point in the Max Compact panel should have the same diameter as the fastener. For each panel, a fixed point is placed as close as possible to the center of the panel element. All other fastening holes are designed as sliding points.

Sliding Point:

Based on how much space is needed for expansion, the diameter of the drill hole in the substructure should be that much larger than the diameter of the fastening means. The screw head should always cover the drill hole. The fastening means is to be set such that the panel can move. The screws must not be too tight. The center of the hole in the substructure must match the center of the hole in the Max Compact panel. Drill with a centering aid!

The panels should be fastened from the middle outwards.

The Compact panels can be fastened in different ways, but due to the material characteristics it is always important to ensure that they are installed in a tension-free manner. The fastening can be done mechanically with screws from the bottom. The screws can either be screwed directly into the panel or screw-in sleeves with external and internal threads (e.g. sleeves from the company Rampa) can also be used.

Should the panels be fastened directly by screw or if a screw-in sleeve is used, it should be noted that the panel must be pre-drilled one thread smaller than the screw or sleeve and that a wall thickness of at least 2.0 mm is maintained after subtracting all tolerances. Suitable screws are those with a metric thread and a flat head. Do not use counter sunk screws. If necessary, use washers/rosettes.

Please observe our recommendations for drilling blind holes vertically and parallel to the panel surface in the chapter Drilling on page page 24.

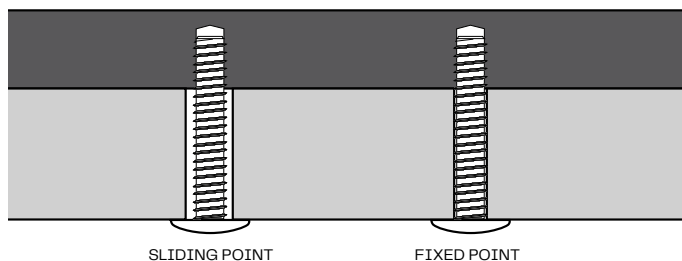

Fig. 8

FASTENING DISTANCES FOR MECHANICAL FASTENING



Fig. 9

MAX COMPACT			
Thickness (mm)	Fastening distance (mm)	Edge distance (mm)	Free overhang (mm)
12	550	20-80	50

Tabelle 1

Glued fastening

An alternative to the hidden, mechanical fastening is gluing the Max Compact panels with especially suitable adhesive systems. Well known facade adhesive systems from companies such as Innotec, Sika and MBE are suitable.

To align the Max Compact panels, we recommend that you only remove the cover film from the corner of the double-sided adhesive tape. This is because the weight of the panel can cause the double-sided adhesive tape to immediately adhere to its surface, making it difficult to move/align the panel.

Please observe the processing guidelines of the adhesive manufacturer.

It is always recommended to test the glue first under local conditions. When working with adhesives, solvents and hardeners, the safety regulations for occupational safety must be observed.

FASTENING DISTANCES FOR GLUED FASTENING

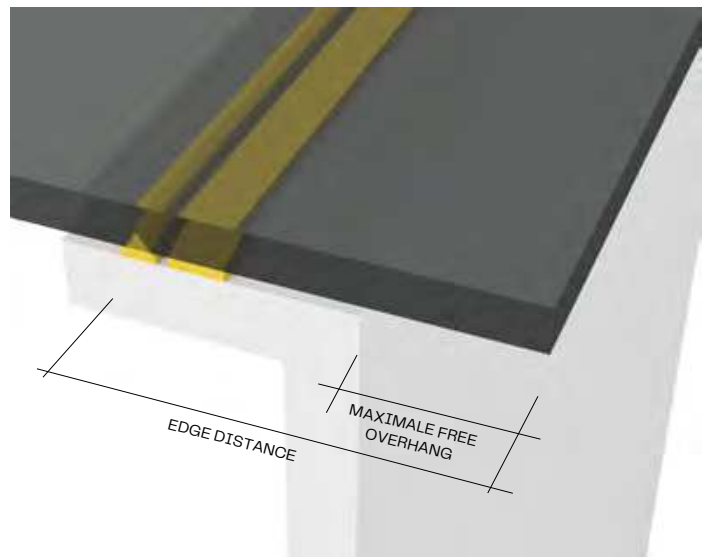

Fig. 10

MAX COMPACT			
Thickness (mm)	Fastening distance (mm)	Edge distance (mm)	Free overhang (mm)
12	300	20-80	50

Tabelle 2

WORKTOP JOINTS

When making corner joints, it must be ensured that the kitchen base cabinets are aligned and any height differences should be compensated for using spacers. Worktop joints must be made using suitable connection means. Please note when using glue for worktop joints that a wall thickness of at least 3 mm is maintained after subtracting all tolerances.

Suitable connection means for worktop joints are for example dowels, grooves, biscuits, special millings etc.

Please observe our recommendations for drilling blind holes vertically and parallel to the panel surface in the chapter Drilling on page 24.

Using only glue for worktop joints is not recommended! Glued corner joints and worktop extensions should always be supported with mechanical connections.

When making worktop joints and connections to other furniture parts, walls, etc., please observe the necessary expansion space for a tension-free movement of the Max Compact panels.

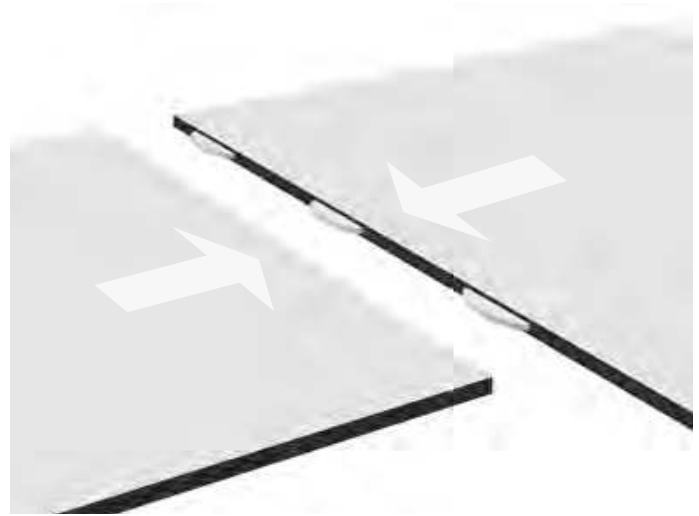

Fig. 11

Sink and glass top stove installation

When installing glass top stoves and sinks, please observe the following:

- Due to the material characteristics of Max Compact panels, it must be ensured that there is sufficient expansion space when installing the panels. As a rule of thumb, calculate 2 mm of expansion space for each meter of panel.
- Recesses/outlets must always be made with an inner radius of at least 5 mm. Pointed corners are not recommended.
- Please ensure that all loads can be borne by the entire construction (e.g. with a full sink).
- When milling the Max Compact panels, make sure that at least 50% of the panel thickness remains.
- For a 12 mm worktop made of Max Compact panels, the milling depth should be no more than 6 mm. In the case of deeper milling, additional support of the worktop with a suitable substructure in this area is recommended.
- For a perfect surface that is easy to clean, we recommend not milling the surface of Max Compact panels.

INSTALLATION OF GLASS TOP STOVES

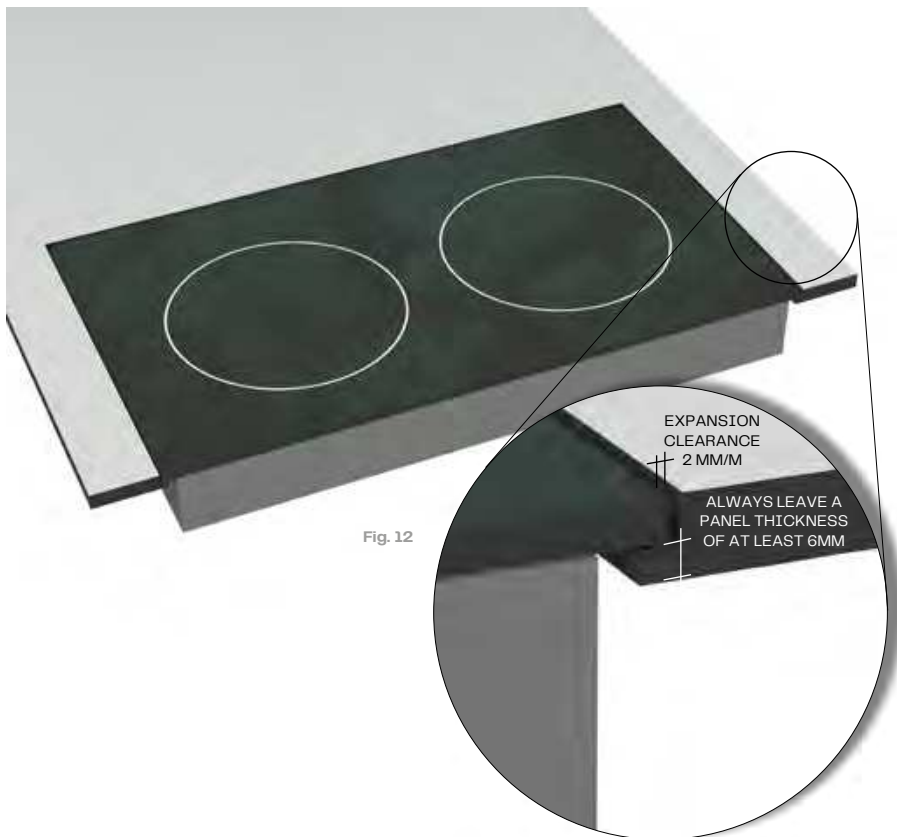

INSTALLATION OF A RECESSED SINK

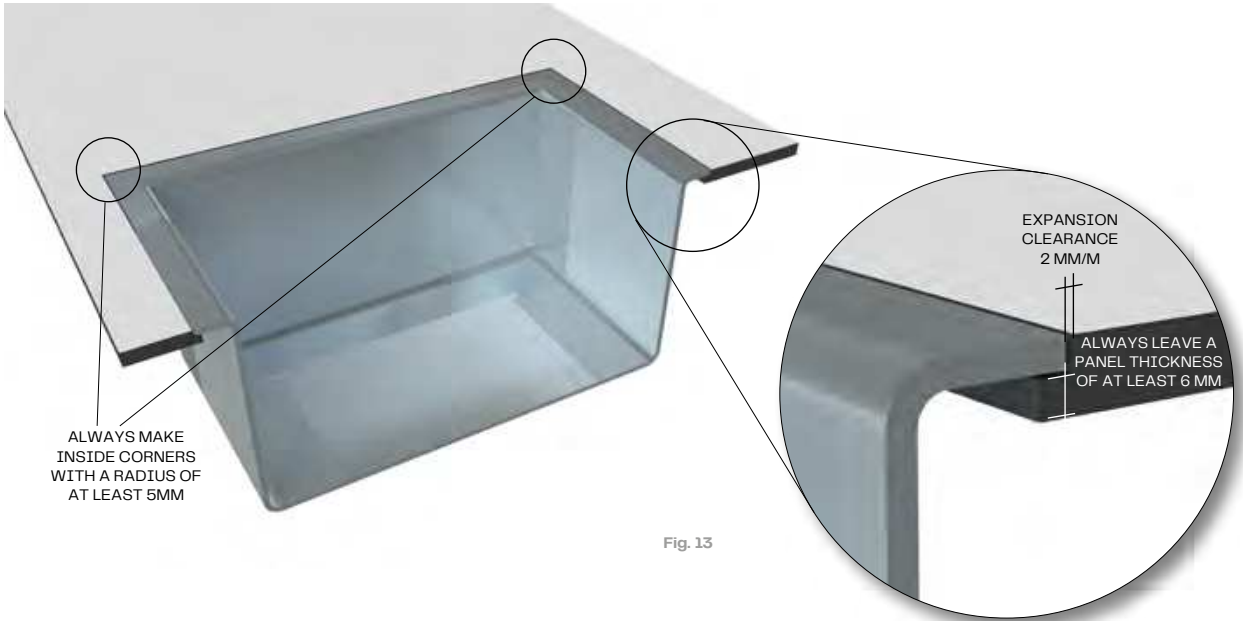

INSTALLATION OF BOTTOM MOUNT SINKS

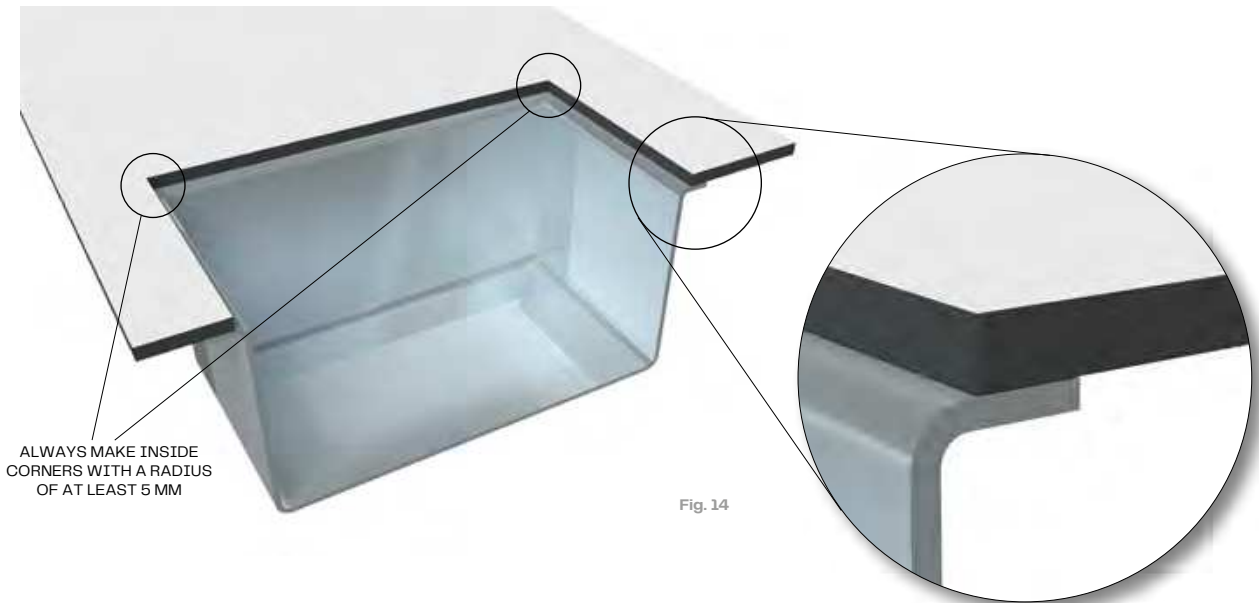

The processing of Max Compact panels

GENERAL

The surface area of Max Compact panels contains high-quality melamine resins and is therefore highly resistant. The processing properties of the Max Compact panels are similar to those for the processing of hardwood. Hard metal cutting tools have been tested and are indispensable when working with Max Compact panels. If a long tool life is required, diamond-tipped (DP) tools should be used. Sharp blades and smooth functioning are both necessary elements to ensure a faultless processing of the material. Breaking-off, splintering and chipping of the decorative side is a result of incorrect handling or unsuitable tools.

Machine tables should be as flat and smooth as possible, so that no chips collect - which can damage the surface area. The same also applies for work surfaces and the controlling of hand-held machines.

Safety measures

This is simply a list of the recommended personal protective equipment. The standard required protective equipment for the given field of work should be used (work clothes, safety boots, hairnets,...).



GLOVES

Non-bevelled cut edges are sharp and pose a risk of injury. To protect against the handling of freshly cut Max Compact panels, gloves of protection category ii with a minimum cut resistance of 2 should be used.

EN 388		Mechanical risks	
		The higher the digit, the better the test result.	
Test resistance	Digit		
Abrasion	0 - 4		
Bladecut	0 - 5		
Tear	0 - 4		
Puncture	0 - 4		



EYE PROTECTION

As with the manufacturing of any other wood, tightly-sealed eye protectors must be worn when working with Max Compact.



DUST PROTECTION

As with the manufacturing of any other wood, the processing of Max Compact panels can create dust. For sufficient respiratory protection, dust mask filters for e.g. should work.



HEARING PROTECTION

During the mechanical treatment of Max Compact panels the sound level can rise to above 80 dBA. Please ensure that you have adequate ear protection at all times when working with these materials.

General processing guidelines

When working with Max Compact panels the ratio between the number of teeth (z), the cutting speed (vc) and the feed rate (vf) must be observed..

	v_c	f_z
	m/s	mm
Saw	40 – 60	0,02 – 0,1
Mill	30 – 50	0,3 – 0,5
Drill	0,5 – 2,0	0,1 – 0,6

Tabelle 3

CALCULATION OF CUTTING SPEED

$$v_c = D \cdot \pi \cdot n / 60$$

v_c – cutting speed

D – tool diameter [m]

n – tool rotational speed [min⁻¹]

CALCULATION OF FEED SPEED

$$v_f = f_z \cdot n \cdot z / 1000$$

v_f – feed rate [m/min]

f_z – tooth feed

n – tool rotational speed [min⁻¹]

z – number of teeth

CUTTING MATERIAL

Tools with hard blades (e.g. HW-Leitz) can be used.

In order to extend tool life, the use of DP-tipped tools (DP polycrystalline diamond) is recommended..

GENERAL ADVICE

If chip removal is not carried out regularly, this can quickly lead to damage of the blade. As a result the required engine power is increased and the tool life will be shortened.

If the shavings are too small they will then scrape and eventually blunt the tool, therefore leading to a short tool life.

For single cuts, it is imperative that the vibration of the panels is prevented using used panels.

Stack height is in compliance with machine capacity.

Cutting

VERTICAL PANEL SPLITTING, TABLE AND SLIDING TABLE SAWS WITHOUT SCORING UNIT

For **circular saw blades with a positive rake angle** and saw shaft under the work piece. Due to the positive rake angle, the cutting pressure takes effect using the stable table support.

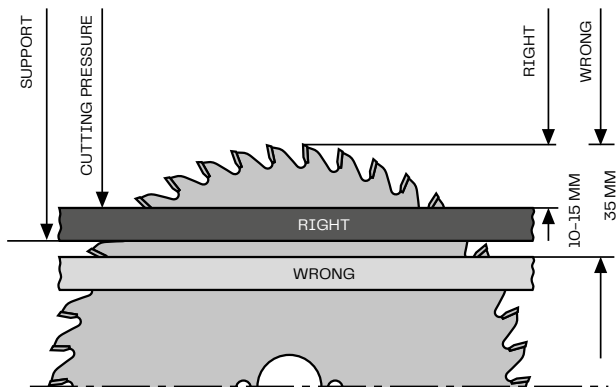

Fig. 15

For **circular saw blades with a negative rake angle** and saw shaft above the work piece. Through the negative rake angle, the cutting pressure takes effect using the stable table support.

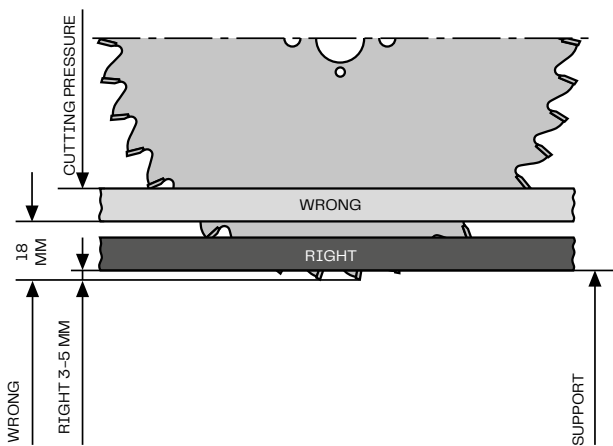

Fig. 16

Adjustment

- visible side upwards;
- very narrow saw guide;
- smooth alignment of the Max Compact panels on the workbench with the saw blade;
- correct blade protrusion.

Depending on the blade protrusion, the entrance and exit angles and therefore the quality of the cutting edges will change. If the upper cutting edges are unclear, the saw blade will need to be adjusted to a higher level. The saw blade must be adjusted to a lower level for an unclear cut of the underside. This is how the best height adjustment is determined.

SLIDING TABLE SAWS AND PANEL SPLITTING MACHINES WITH SCORING UNIT AND PRESSURE BEAMS.

Scoring circular saw blade:

In order to achieve a good cutting edge quality on the saw exit side, the use of a scoring unit is recommended. The cutting width of the scoring circular saw blade is slightly bigger than that of the main circular saw blade so that the exiting teeth of the main saw no longer touch the cutting edge.

As a secure and smooth circulation of the work pieces can only be guaranteed using a pressure device, divided scoring circular saw blades are used on the table and sliding table machines.

Panel splitting unit with scoring aggregate and pressure device.

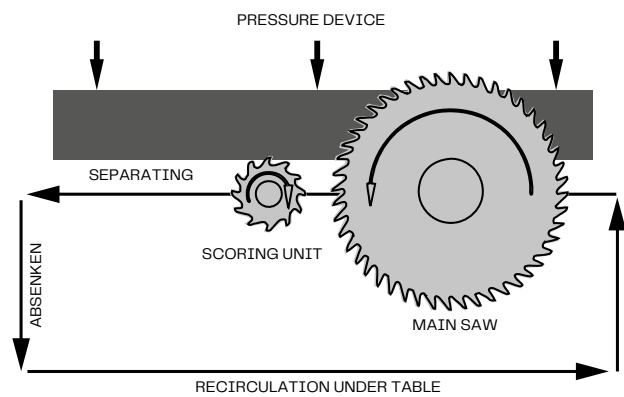

Fig. 17

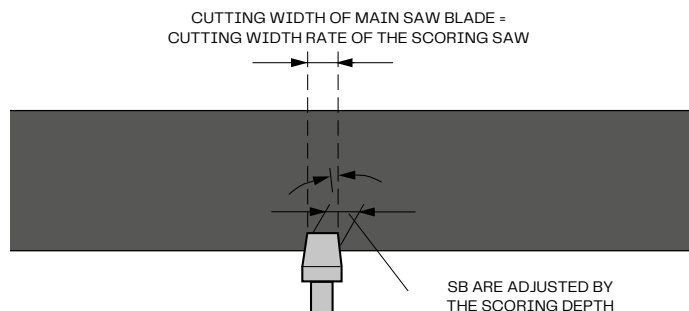

Fig. 18

Operating diagram of the conical scoring circular saw. For the maintenance of tools (always step-by-step), the cutting widths must be aligned with one another.

TOOTH FORMS

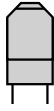

Fig. 19

TR/TR (Trapezoid tooth/ trapezoid tooth)

Preferred tooth forms for the cutting of hard abrasive laminates.



Fig. 20

FZ/TR (Flat tooth/trapezoid tooth)

Tooth form for the processing of laminates and Compact panels.

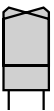

Fig. 21

WZ/FA (Variable tooth with bevel)

An alternative to FZ/TR tooth.



Fig. 22

HZ/DZ (Concave tooth with bevel)

Tooth forms for excellent and below on machines without scoring units.



Fig. 23

HZ/FA (Concave tooth with bevel)

Similar use to hz/dz only with longer machine life without scoring units.

Cutting with handheld tools

For straight cuts with handheld circular saws, a stop bar or guide rail should be used. Saw blades suitable for hard metal use should be used. The sawing takes place from the panel underside using the following tooth forms:

- WZ/FA for coarse cuttings
- FZ/TR for clean cuts

of Max Compact panels and panels which are bonded on both sides.

Milling machines – edge processing

EDGE PROCESSING BY HAND

For the finishing of edges, files are suitable. The file direction moves from the decorative side to the core. For broken edges, fine files, plane files, sand paper (100–150 grain) or scrapers can successfully be used.

EDGE PROCESSING WITH HANDHELD MACHINES

To mill bevels electric hand planes with bevel or bevel grooves can be used. Hand routers are used along with hard metal tools for special tasks (e.g. wash basin recess, trax-coupling etc.).

In order to protect the Max Compact panel surface areas, the supporting surface of the hand routers should be covered with for e.g. panel parts, no felt! Milling shavings should be carefully removed.

We recommend hard metal tipped milling cutters, which are also available with indexable inserts. For a better functioning of your tools, heightadjustable milling cutters are preferable. The sharp edges will be broken down afterwards.

EDGE PROCESSING WITH WITH STATIONARY MACHINES

For milling work on the Max Compact panels, the optimal ratio of teeth, cutting speed and feed rate should be observed.

If the shavings are too small, the machine will scrape (burn) and therefore blunt quickly, meaning it only has a short service life. On the other hand, if the shavings are too big, the edges will be wavy (strokes) with an unclean finish. High rotational speeds are not the only criterion for good quality edges!

When working with the hand fed machines, only those with the marking ‚MAN‘ or ‚BG-test‘ should be used.

Furthermore, the given machine speed range should neither be exceeded nor fallen short of for reasons of safety. Hand fed machines should only be used when working in the opposite direction.

FINISHING OF MILLED EDGES

Sand the edge surface and smooth out the sharp edges with sandpaper. When processing edges, hand planes with steel residue can be used. It is also recommended that HSS blades are used. The cutting angle of the blade should be approx. 15°C.

For the processing of Max Compact panels, milling heads with an HW indexable insert blade or diamond-tipped cutter are suitable.

The black panel edges can be given a uniform color by wiping them with silicone-free oil.

EXAMPLES OF POSSIBLE EDGES AND CORNERS

For Max Compact panels no edge protection is necessary.

For visible edges, there are a wide variety of structural possibilities.

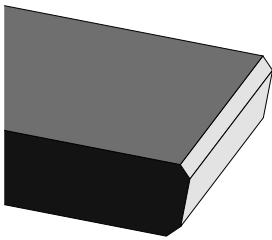

STANDARD BEVEL / TYP B

Fig. 24

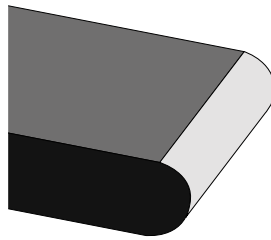

MILLING CONTOUR 3 / TYP G

Fig. 28

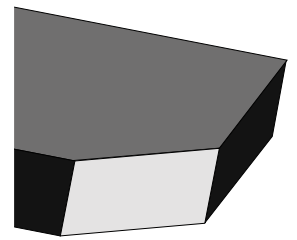

BEVELLED CORNER / TYP L

Fig. 31

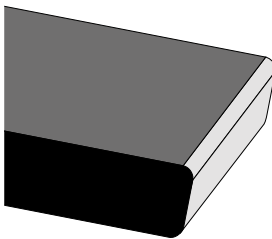

ROUNDED EDGES ON BOTH SIDES / TYP D

Fig. 25

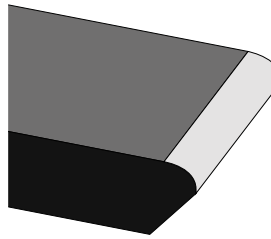

MILLING CONTOUR 4 / TYP H

Fig. 29

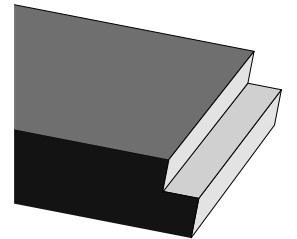

MILLING NOTCH / TYP M

Fig. 32

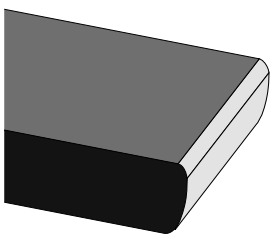

MILLING CONTOUR 1 / TYP E

Fig. 26

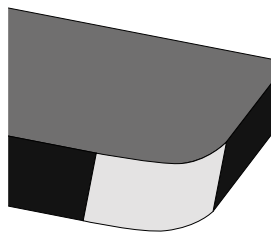

ROUNDED CORNER / TYP K

Fig. 30

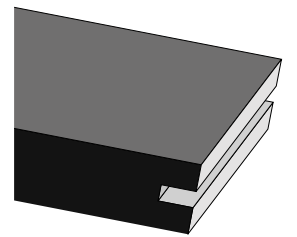

MILLING GROOVE / TYP N

Fig. 33

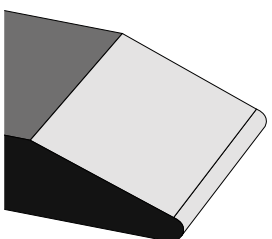

MILLING CONTOUR 2 / TYP F

Fig. 27

Note:

The current data sheet on processing possibilities of Fundermax can be found at: www.Fundermax.at under 'Downloads' – 'ordering facilities'.

Joining

TO JOIN IN CLIMB OR CONVENTIONAL (E.G. VARIABLE MILLING)

The following machines are used:

Spindle moulding machine, edge processing machines and Double-end profiler (hand fed in conventional motion only)

INFORMATION ON MILLING EQUIPMENT:

Milling head with reversible blades, divided cuts and reciprocal shaft angle for a splinter-free joining edge. Machine creates cylindrical finish for large material thickness (approx. 0.10 mm). For completely straight cutting surface, the Diamaster joint cutter WF 499-2 is recommended.

You will find detailed information at company Leitz.

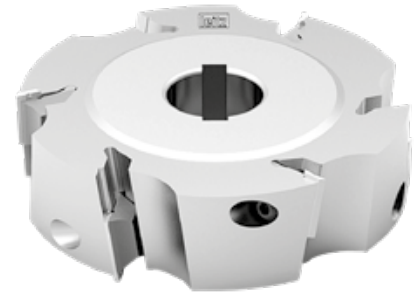

LEITZ JOINT MILLING HEAD-
INDEXABLE INSERT MODEL

Fig. 34

FOR SOUNDPROOF JOINTS ON NARROW WORK PIECE SURFACES CLIMB AND CONVENTIONAL (VARIABLE MILLING)

The following machines are used:

Edge processing machines, copy milling machines etc.

INFORMATION ON MILLING EQUIPMENT:

Composite tool with mutual shaft angle for a splinter-free joining edge and straight narrow surface. Noise reduction up to 5dBA and highly efficient collection of shavings (over 95%).

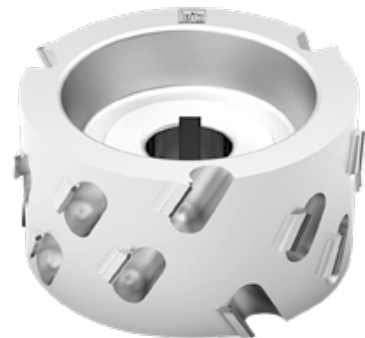

LEITZ DIAMASTER JOINT CUTTER DP-TIPPED

Fig. 35

Routers

For processing using router machines and machining centres, solid hard metal twist or diamond-tipped router drills are best suited. Work pieces must be well clamped and if necessary, additional mechanical tensioners can be used to support the suction cup. It is also recommended that shrink-fit thermoGrip jaw chucks are used instead of collect chucks as they offer the highest stability and stiffness of all known tensioning systems for shaft tools.

A satisfactory processing result can only be achieved if there is sufficient stiffness in the machine. ‚Light‘ radial machines are only of limited suitability. Ideal: Stiff portal machines.

FORMAT, GROOVE AND FINISH MILLING

For high requirements of cut quality – Z3 model for high feed rates.

The following machines are used: Router machines with/without cnc control, machining centres, special milling machines with milling spindles for use with shaft work tools.

INFORMATION ON MILLING EQUIPMENT:

Marathon laminate for enhanced service life and reduced gradient for the formation of built-up edges. Usually used for roughing end mills, cutting allowances of approx. 1–2 mm mirror grinding on the rake surface for processing.

ROUTER CUTTERS FOR FORMATTING, AND GROOVING WITH LEDGE FREE CUT

The following machines are used: Router machines with CNC control, machining centres, special milling machines with milling spindles for use with shaft work tools.

INFORMATION ON MILLING EQUIPMENT:

Negative rake angle of the blade for chip-free finish when grooving and for support of the work piece tensioning for small mill parts. Can be re-sharpened 5 to 8 times with normal blunting. Short, stable cutting blade therefore particularly suited for grooves and shaping of abrasive and hard-to-cut materials.



LEITZ SPIRAL ROUTER MACHINE
MARATHON FINISH

Fig. 36



LEITZ ROUTER MACHINE DIAMASTER PLUS

Fig. 37

CNC processing

The following points should be taken into account when working with Max Compact on CNC devices.

FIXING PANELS ON A MACHINE TABLE

There are basically two ways to fix or tension Max Compact panels on machine tables depending on the type of processing to be performed: When milling to size or edging both sides of a panel section, it is recommended to fix the panel in place using suction cups at specific points. Notice: The proper distance between the suction cups must be observed!

When milling to size, edging one side, making perforations or free-form milling a panel section, it is recommended to fix the panel in place using MDF protective boards (protective boards can be used several times).

The following applies for both options: It must be ensured that the suction cups provide sufficient holding power for the work to be performed. If the suction cups do not provide sufficient fixing or tensioning power, the suction cup seals (e.g. the sealing rings) must be checked.

SPACING OF THE SUCTION CUPS

As a rule, the material being processed should not be subjected to any vibrations. Therefore, it is important that the suction cups are placed at an appropriate distance from the freely protruding panel edge based on the thickness of the panel. The following applies: the more suction cups and the smaller the distance from the free protruding edge of the panel, the cleaner the milling pattern. As a rule of thumb, suction cups should be placed in the area to be processed in a grid of max. 300 mm with a maximum distance from the free protruding edge of the panel of no more than 30 mm. The best results are achieved by using an MDF protective board (e.g. 19 mm thick), as this enables a full-surface fixing of the Max Compact panel on the machine table with suction cups.

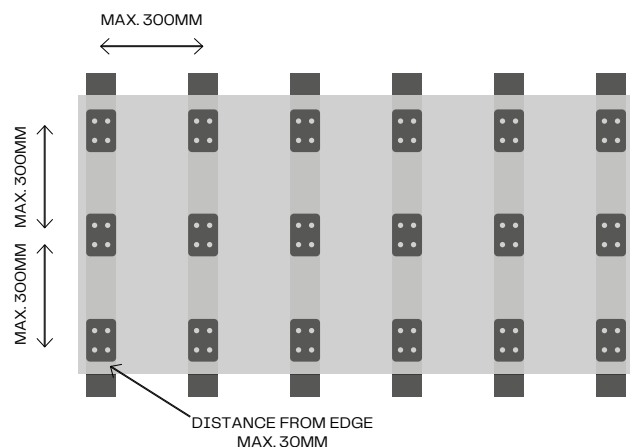

SPACING OF THE SUCTION CUPS

Fig. 38

CHOICE OF MACHINING TOOL

Generally speaking, Max Compact panels can be machined with solid carbide (VHM) and diamond (PCD) milling tools. The basic prerequisites for a clean milling pattern and a long service life are vibration-free tool holders and spindles. NOTE: The ball bearings must be properly maintained!

Diamond tools have proven particularly suitable for processing a large amount of panels or a high number of running meters. Smooth-running milling cutters with a shank diameter of min. 10 mm in combination with straight continuous DIA cutting edges (2+1 knife) are especially suitable for format milling.

It is essential that the feed rate and the cutting speed be adjusted for the specific job and cutter based on the material being processed. We recommend always consulting the tool supplier first.

CLAMPING SYSTEM OF THE MILLING TOOL

It is essential that the spindle be centered in the chuck to ensure the smooth running of the milling cutter. The more centered and play-free the milling cutter can be clamped in place, the better the result. Most machines are equipped with common tool holders such as collets, hydro grips or shrink chucks.

For the professional CNC machining of larger jobs, a hydro grip tool holder or shrink chuck is recommended as they guarantee the best tool clamping. It is important to ensure the proper maintenance of all moving parts such as plain or ball bearings in order to avoid vibrations in every direction!

EXTRACTION

The extraction or the extraction power must be adjusted accordingly for the material being processed to ensure that all the shavings are optimally removed.

If the extraction is not strong enough, there is a risk of heat development. This is due to shavings that remain between the cutter and the panel edge. High friction occurs at this point because the cutter can not eject the material any further. This can lead to burn marks on the panel edge.

CNC MACHINING BY FUNDERMAX

Fundermax has their own machining center – Compact Elements. We are happy to machine Max Compact, Max Compact Exterior, Max HPL and m.look panels to your specifications. Simply contact our customer service center for more information.

Edges and grooves

Grooved edges on Max Compact panels should always be bevelled, not sharp-edged! This spares the corners of the machine (indexable inserts) and prevents a notch effect. The service life can often decrease dramatically depending on the height adjustment, the machine type and form, the cutting requirements and support material. For high volume production, the use of diamond-tipped machines should be considered.

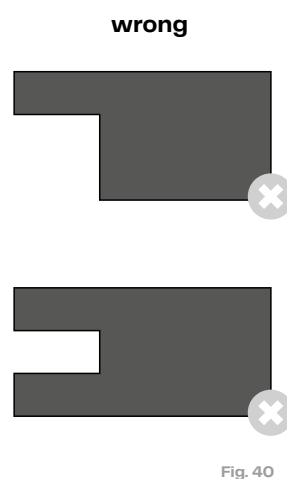
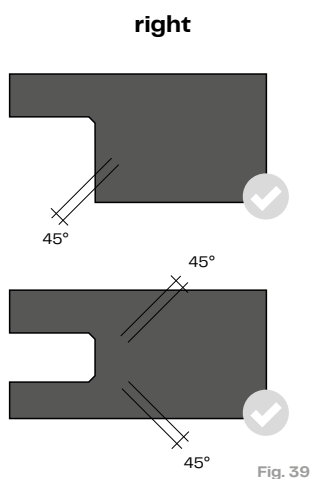

Inner notches and cut-outs

With inner notches and milling grooves, the corners are consistently rounded off. The inner radius should be kept as large as possible (minimum radius 5 mm). For inner notches and milling grooves over 250 mm sidelength, the radius must be gradually increased in line with the side-length.

Inner notches can be directly formed using the milling cutter or they can be pre-drilled with a corresponding radius, before the cut from drill hole to drill hole is milled. Sharp-edged corners are weak and lead to the formation of cracks due to tension.

Moreover, all edges must be ripplefree. If, sharp-edged corners are required for constructive reasons, this can only be achieved through a combination of compact panel blanks. The suitable cutting, milling and drilling machines for the production of inner notches and milling grooves are described in the previous sections.

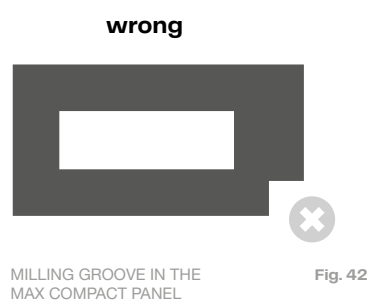
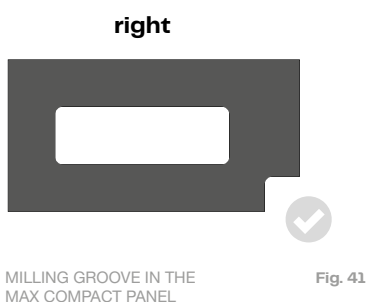

MACHINE SUPPLIERS

Leitz GmbH & Co. KG
Leitzstraße 80
A-4752 Riedau
Tel: +43 (0)7764/8200 – 0
Fax: +43 (0)7764/8200 – 111
Email: office.riedau@rie.leitz.org
www.leitz.org

OERTLI-LEUCO Werkzeuge GmbH
Industriepark Runa
A-6800 Feldkirch
Tel: +43 (0)5522/75787-0
Fax: +43 (0)5522/75787-3
Email: info@oertli.at
www.oertli.at

Ledermann GmbH & Co. KG
Willi-Ledermann-Strasse 1
D-72160 Horb am Neckar
Tel: +49 (0)7451/93 – 0
Fax: +49 (0)7451/93 – 270
Email: info@leuco.com
www.leuco.com

Drilling

Solid hard metal twist or dowel drills are used for drilling. In machining centres, the use of the main spindle instead of the drilling beams for a rpm of 2000 – 4000 min⁻¹ and a feed rate of 1.5 – 3 m/min, is recommended. The exit speed of the drill must be carefully selected so that the melamine surfaces of the Compact panels are not damaged.

Shortly before the drill exits the work piece in full diameter, the feed rate must be reduced by 50%. When drilling through-holes, the counter-pressure should be built up using hardwood or equivalent material to prevent break-offs of the melamine surface.

For the screwing of blind holes perpendicular to the panel levels, please ensure:

- Tap drill diameter (D) = screw diameter minus approx. 1 screw channel depth.
- Drilling depth (a) = panel thickness minus 2 mm after deducting all tolerances.
- Screw-in depth = drilling depth minus 1 mm

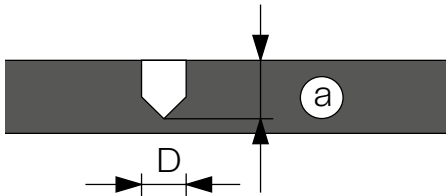

Fig. 43

For screw fittings parallel to the panel level, please ensure:

- The residual thickness (b) of the Max Compact panel must be at least 3 mm after deducting all tolerances.
- The hole diameter of the drillings parallel to the panel surface must be selected in such a way to avoid any splitting of the compact panels when tightening the screws.
- For screw fittings parallel to the panel surface, metal sheet and chip boardscrews are suitable.
- In order to ensure respective stability, a minimum depth of engagement of 25 mm is necessary.

It is imperative that tests to establish the correct drill diameter are carried out.



Fig. 44

For the drilling of Compact panels, drills for plastics are best suited. This means twist drills with a point angle of $\leq 90^\circ$. They have a large gradient and chip space.

The sharp drill bits mean that these drills are also very suitable for the drilling of through-holes as they cut cleanly through the underside of the material.

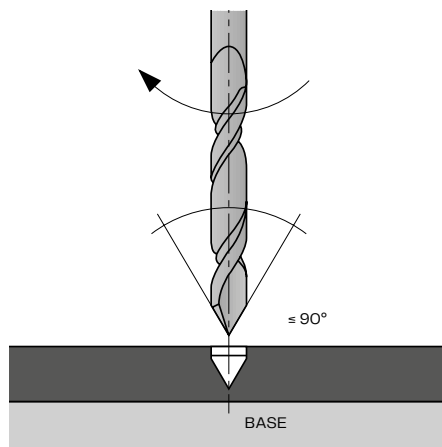

Fig. 45

UNIVERSAL DRILLING OF BLIND AND THROUGH-HOLES

The following machines are used:

Point-to-Point drilling machines, through feed drilling machines, CNC machining centres, box column drill, inlet-fitting drilling machine, drilling units, hand drills.

INFORMATION ON THE DRILLS

Flat roof drill bits. Shaft diameter identical to blade diameter. Adaptable for shaft-D 10 mm with reducing bush TB 110-O or Pm 320-O-25.



LEITZ-DRILL HW-SOLID, Z2

Fig. 46

TIERED HINGE DRILLING

Particularly for screw-in hinges in door manufacturing.

The following machines are used:

CNC machining centres, drilling units, hand drills.

INFORMATION ON THE DRILL:

Model HW Z 2, 2-tiered. 1tier with roof drill bit.



LEITZ-DRILL SHAFT 10 MM

Fig. 47

DRILLING OF BLIND HOLES

In particular dowel holes in cabinetry. Particularly suitable for the tear-free drilling of blind holes in visible quality as well as the processing of panel materials. Not suitable for through-holes!

The following machines are used:

Point-to-Point drilling machines, through feed drilling machines, inlet fitting drilling machines, drilling units, CNC machining centres.

INFORMATION ON THE DRILL:

Roughing geometry with extremely clean cut. Model HW-solid with highly wear-resistant HW varieties. High stability and long service life. Polished chip space for minimal friction and feed force.

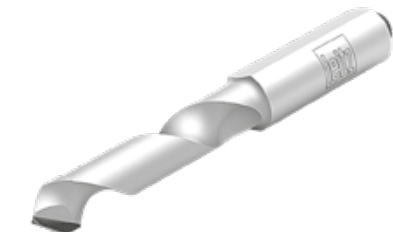

LEITZ-DRILL SHAFT 10 MM

Fig. 48

Pre-punching ensures better control for hand drilling.

Diamond-tipped drills are not suitable for compact panels.

Basics

Screws should never come into contact with the edges of the drillhole. They must have clearance on all sides so that the material can adapt to temperature and moisture fluctuations. In this way, the formation of cracks around the holes as well as panel warping, is avoided.

If raised countersunk-head screws are used, underlay rosettes are necessary.

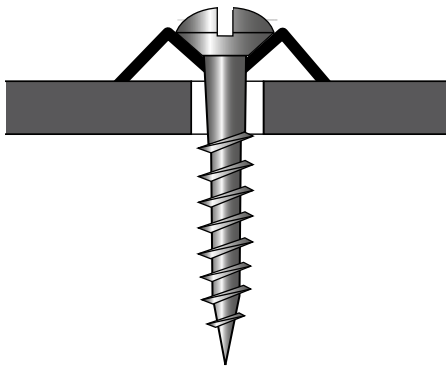

CHEESE-HEAD SCREW WITH
UNDERLAY ROSETTES

Fig. 49

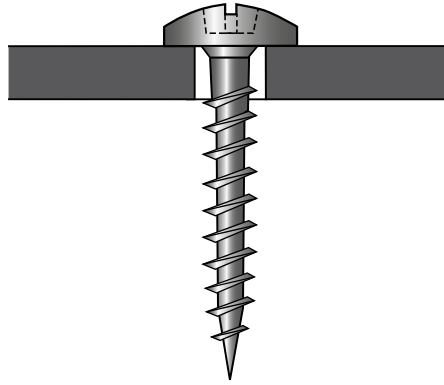

ROUND-HEAD SCREW COVERING
SLIDE POINTS

Fig. 50

Attention to V-joints an expansion clearance
on plat fragmentations!

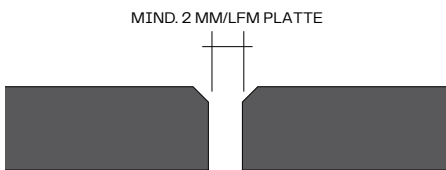

V-JOINTS WITH EXPANSION CLEARANCE

Fig. 51

Bonded edge joints

In order to increase the adhesive surface, special bevel sections can be milled (Leitz) or, joints with groove or external springs (ideally compact strips) can be produced.

During the adhesive process, it must be ensured that both bonded panels are joined in the same running direction.

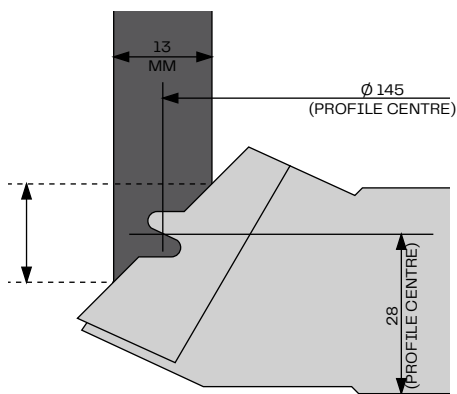

LEITZ PROFILE CUTTER HEAD
PRO 610-1-5

Fig. 52

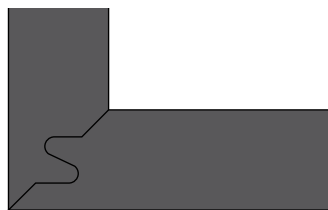

CORNER JOINT WITH
LEITZ PROFILE CUTTER

Fig. 53

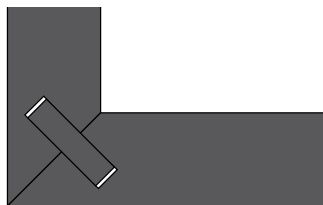

CORNER JOINT WITH GROOVES
AND EXTERNAL SPRINGS

Fig. 54

Glueing

Adhesive joints should be carried out in such a way that dimensional changes of the Max Compact panels are allowed. The panels must only be bonded in the same running direction and conditioning, otherwise tensions may occur. **Tip:** identify decorative design before cutting.

Max Compact panels have twice as much shrinkage and swelling room breadthwise than lengthwise. If adhesive joints are put under frequent pressure, they should be supported using mechanical joints.

THE GLUEING OF MAX COMPACT PANELS ONE BELOW THE OTHER

■ Stiff adhesive joints:

Reactive adhesives such as polyurethane and epoxy glue.

Caution when using PU adhesives. These adhesives foam and the surface of the Compact panels must be cleaned before the adhesive cures as otherwise only a mechanical cleaning will be possible. This can damage the surface of Max Compact panels.

Dispersion adhesives (white glue) and condensation adhesives (PVA glues) are not suitable.

■ Elastic adhesive joints:

The following adhesives can also be used to support mechanical connections.

Adhesions using PUR Kitten e.g.: Würth 'glues and seals', Sikaflex 252, Teroson-Terostat 92, Dinitrol 600, Dinitrol 605, Dinitrol F500, Dinitrol 410 UV Plus, from Fuller ICEMA 101/25 + curing agent 7 etc. have been tested.

GLUEING OF MAX COMPACT WITH WOOD

After sanding the Max Compact panels, they can be bonded to wood materials using high-quality PVAc glues (white glue). A condition being that the material can absorb the glue moisture during the setting process.

GLUE APPLICATION PROCESS

- The Max Compact panel, as well as the material to be glued, must be thoroughly cleaned before gluing. They must be free of dust, grease, oil and sweat stains or coarse particles that can mark the surface after gluing. When gluing, the ambient climate should be 15 – 25 °C and 50 – 65% relative humidity.
- The glue joint quality must be selected according to the bonding quality of the substrate and the load.

Increased water resistance of the glue joint does not increase the water resistance of the substrate material!

- The specifications of the selected adhesive manufacturer must be observed. It is always recommended to test the glue first under local conditions. When working with adhesives, solvents and hardeners, the safety regulations for occupational safety must be observed.

PRESS TEMPERATURE

- Tension-free composite elements can be produced most reliably at pressing temperatures of 20 °C, i.e. room temperature. Higher temperatures allow a reduction in the setting time. However, since the temperature also leads to dimensional changes that may vary between the Max Compact panels and the other materials, 60 °C should not be exceeded in order to avoid increased stress which can lead to the distortion of the elements.

ADHESIVES

Dispersion adhesives

e.g. PVAc glues = casein condensation

Resin adhesives

e.g. urea, resorcinol and phenolic glues

Contact adhesives

e.g. polychloroprene adhesives

Reactive adhesives

e.g. epoxy, unsaturated polyester, polyurethane adhesives

Hot melt adhesives

for edgebanding, based on EVA, polyamide or polyurethane.

Cleaning recommendations

Please start the cleaning procedure for unknown stains with basic cleaning, cleaning procedure a to g in order to perform the desired success. To prevent streaking you have to perform a final cleaning.

BASIC CLEANING

Clean the surface just with pure hot water and use a soft sponge – (do not use the abrasive „green“ side of the sponge), use a soft cloth or a soft brush (e.g. nylon brush).

CLEANING PROCEDURE A

Same as basic cleaning, in addition use common household cleaners without abrasives e.g. Dish detergent (Palmolive, Fairy), window cleaner (Ajax, Frosch).

CLEANING PROCEDURE B

If the contamination is not removable with the cleaning procedure A, you can use a solution of soft soap – water (1:3). Depending on the degree of pollution leave it on the surface for a couple of minutes..

CLEANING PROCEDURE C

Same as basic cleaning, but you may additionally use organic solvents (acetone, alcohol, turpentine, thinner). For persistent dirt pollution try to clean mechanically.

Caution: avoid scratching, use plastic or wooden spatula.

CLEANING PROCEDURE D

Same as basic cleaning, but you may additionally use commercially available disinfectants. Steam cleaning is possible. Take care of the supporting material (e.g. wood beams, wall paneling, insulation, ...), to avoid wetting.

CLEANING PROCEDURE E

Remove immediately! If necessary, perform cleaning procedure c and final cleaning procedure.

CLEANING PROCEDURE F

Rub off the surface with a soft cloth or a soft sponge dry. If contaminants cannot be removed, use silicone remover (e.g. Molto).

CLEANING PROCEDURE G

Following the initial cleaning, liquid cleaners can be used with polishing chalk (Cif, ATA). Do this procedure only occasionally! For persistent limescale acidic cleaning agents may be used (for example, 10% acetic acid or citric acid). Subsequently do the final cleaning.

SCHLUSSREINIGUNG

Detergents have to be removed with water completely to avoid streaking. Finally clean with hot water and rub off the surface with an absorbent cloth or paper towel (kitchen roll).

When cleaning with solvent:

Observe the accident prevention regulations!
Open windows! No open flame!

TYPE OF STAIN	CLEANING PROCEDURE	TYPE OF STAIN	CLEANING PROCEDURE	TYPE OF STAIN	CLEANING PROCEDURE
Adhesives	C	Grease, fats	A	Stamping ink	C
Bacteriological stains	D	Grease, oil	A, B, C	Synthetic resins	E
Blood	D	Hybrid-gluue	E	Tea	A
Chalk	A	Limescale	G	Two-component adhesive	E
Coal tar (cigarettes)	C	Lipstick	C	Two-components lacquer	E
Coffee	A	Marker	C	Urea-gluue	E
Colored ballpoint pens	C	Marking pen	C	Urine	D
Dispersions (PVAC)	C	Mordant	C	Water marks	G
Dust	A	Paints	C	Water-soluble adhesives	A
Emulsions paints	C	Pencil	A	Water-soluble dyes	A
Excrement	D	Polyurethane foam	E	Wax crayon	C
Fingerprints	A	Rust	G	Wax polish	C
Fitting foam	E	Sealants (like silicone)	F	Wax residue	C
Floor polish	B	Shoe polish	C		
Fruit juice	A	Soap residue	A		
Germs	D	Spray paint	C		

Tabelle 4

FINAL CLEANING

Please ensure that foreign substances (e.g. drilling and machine oils, greases, adhesive residues, etc.) that soil the surface of the Max Compact Exterior panels during storage, installation and use are removed immediately without leaving any residue. We recommend using non-greasy sunscreens (e.g. Physioderm Physio UV 50 Spray), as soiling with conventional sunscreens is often impossible to remove completely even when cleaned immediately.

No responsibility will be accepted for any complaints regarding color, gloss and surface of the panels should these recommendations fail to be observed.

Fundermax Deutschland GmbH
Industriestrasse 1
D-92442 Wackersdorf
infofgermany@fundermax.biz
www.fundermax.de

Fundermax France SARL
3 Cours Albert Thomas
F-69003 Lyon
Tel: + 33 (0) 4 78 68 28 31
Fax: + 33 (0) 4 78 85 18 56
infofrance@fundermax.biz
www.fundermax.fr

Fundermax India Pvt. Ltd.
Sy. No. 7, Honnenahalli Village
Bengaluru-Doddballapur Highway Road
Yelahanka Hobli, Bangalore North Taluk
IND - 560064 Bangalore
Tel: +96113 99211
officeindia@fundermax.biz
www.fundermax.in

Fundermax Italia S.R.L.
Viale Venezia 22
I-33052 Cervignano del Friuli
infoitaly@fundermax.biz
www.fundermax.it

Fundermax North America, Inc.
9401-P Southern Pine Blvd.
US-Charlotte, NC 28273
Tel: +1 980 299 0035
Fax: +1 704 280 8301
office.america@fundermax.biz
www.fundermax.at

Fundermax Polska Sp. z o.o.
ul. Rybitwy 12
PL-30 722 Kraków
Tel: + 48-12-65 34 528
Fax: + 48-12-65 70 545
info Poland@fundermax.biz

Fundermax Russia, Showroom
of.203, bld.2, 10, Nizhnyaya
Syromyatnicheskaya str.,
Moscow, 105120, Russia
Tel: +7 (499)130-3094
fundermax.ru@fundermax.biz
www.fundermax.ru

Fundermax Swiss AG
Industriestrasse 38
CH-5314 Kleindöttingen
Tel: + 41 (0) 56-268 83 11
Fax: + 41 (0) 56-268 83 10
infoswiss@fundermax.biz
www.fundermax.ch

FunderMax GmbH

Klagenfurter Straße 87-89, A-9300 St. Veit/Glan
T +43 (0) 5/9494-0, F +43 (0) 5/9494-4200
office@fundermax.at, www.fundermax.at